

## Turbine flow sensors // VTY15



VTY15

### Your advantages

Series	VTY15
	<ul style="list-style-type: none"> <li>• Space-saving due to compact design</li> <li>• Pressure loss optimized</li> <li>• Low wear and extremely long service life due to high-quality bearings</li> <li>• High measuring accuracy, largely independent of the installation position due to integrated flow straighteners</li> </ul>

### Technical data

<b>Material pipe section</b>	Brass
<b>Flow range</b>	1...45 l/min
<b>Accuracy</b>	±(1 % of range + 0.5 % of reading)
<b>Repeatability</b>	±1 %
<b>Signal output</b>	From 0.8 l/min
<b>Medium temperature</b>	0...90 °C (non-freezing)
<b>Ambient temperature</b>	0...70 °C
<b>Pressure rating</b>	PN 16
<b>Nominal diameter</b>	DN 15
<b>Process connection</b>	G ¾ male thread
<b>Sensor</b>	Hall effect sensor
<b>Output signal</b>	Square wave frequency signal, NPN open collector
<b>Pulse duty ratio</b>	50:50
<b>Pulse rate / K-factor</b>	234 pulses/l
<b>Electrical connection</b>	80 mm single wires with Molex Mini-Fit® Jr. connector (part number 0039014036) optional: 0.5 m PVC cable or 1 m PVC cable
<b>Power supply</b>	4.5...24 VDC
<b>Current consumption</b>	Typ. 1.6 mA

Typical pressure drop

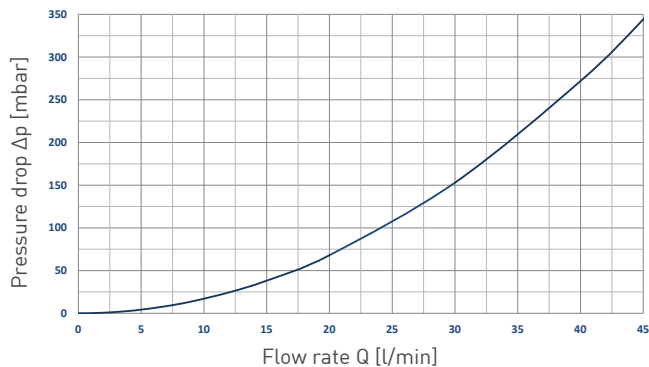

Characteristic curve

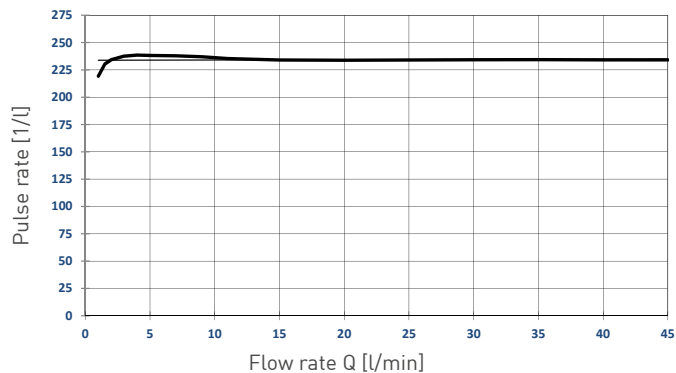

VTY15

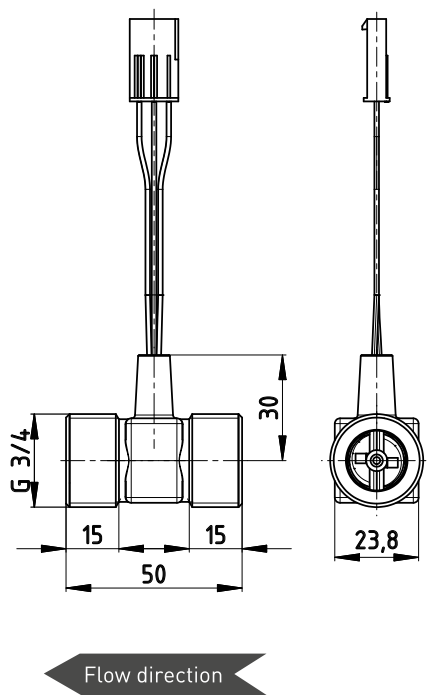

Alternative electrical connection

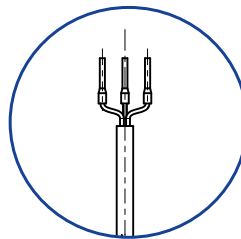

Materials in contact with media	
Pipe section	Messing CW617N-DW
Turbine cage	PPE+PS Noryl™ 30 % glasfaserverstärkt
Rotor	PPE+PS Noryl™ 30 % glasfaserverstärkt
Magnet	Hard ferrite
Shaft	Stainless steel / hard metall
Axial bearing	Sapphire
Radial bearing	PEEK Victrex™
Locking ring	Stainless steel

## Wiring

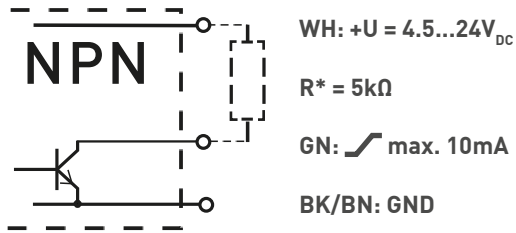

## Colour code

WH = white  
 GN = green  
 BK = black (single wire)  
 BN = brown (PVC cable / Molex)  
 R = resistance

\* Recommended pull-up resistance R ~ 5kΩ

## Pin assignment Molex Mini-Fit® plug

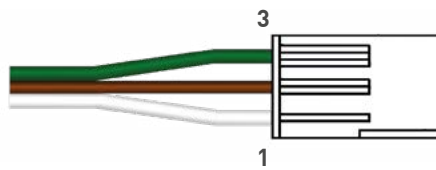
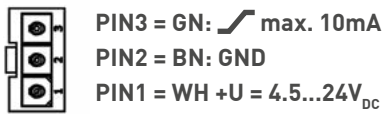

Order code		
<b>Type</b>		
VTY15	VY1545MAHN	
<b>Electrical connection</b>		
80 mm single wires with Molex Mini-Fit® Jr. plug connector		X1A4
0.5 m PVC cable		05A4
1 m PVC cable		10A4
<b>Example order number</b>	<b>VY1545MAHN</b>	<b>X1A4</b>

Note minimum order quantities.

